



Town of Kernersville - Police Admin Offices

134 E. Mountian Street, Kernersville, NC 27284

Furniture Specifications

5.31.2024



939 Burke St., Ste. B, Winston-Salem, NC 27101
viibedesign.com • (336) 724.5813



Furniture Specifications

Manufacturer: Carolina

Item Number: CA-1

Quantity Req.: 5

Location: Office 142, 144, 145, 146, 149

Product: Basket Occasional Table

Model: 447-23SQ

Description: Squircle End Table
Top Finish: Solid Surface
Color: Cameo White (CWS)

Base Finish: Oiled Bronze (H1P)

Contact: Arden Gurney
Jack Fetner Associates
arden@jackfetnerassociates.com





Furniture Specifications

Manufacturer: Coalesse

Item Number: CO-1

Quantity Req.: 1

Location: Lobby 148

Product: Circa Lounge

Model: 451-7460FIK

Description: Circa Inside Wedge 2-Seat Lounge

5 Legs

Legs: Tapered

Leg Finish: V23W Black Walnut

Back Upholstery: COM

Manufacturer: Arc Com

Pattern: Crystal AC-62511

Colorway: Smoke #2



Seat Upholstery: COM

Manufacturer: Momentum

Pattern: Vinci

Colorway: Mineral

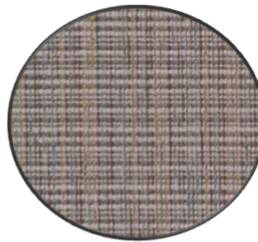

Contact: Carrie Tauber

Storr Office Environments

336-217-4504

ctauber@storr.com

Tammy Rogers-Markle

Momentum

336-279-4596

trogersmarkle@momtex.com



Lauren Gayle

Arc Com

980-253-9896

lgayle@arc-com.com



Furniture Specifications

Manufacturer: Darran

Item Number: DA-1

Quantity Req.: 1

Location: Office 144

Product: U Desk - Central Park -TFL

Description: CPC7236DS017M - K31 - TM30-R, Double Breakfront, Bowfront Single Left Pedestal Desk - Locking, Center Drawer, Right Grommet / Black

CPC4824BR151M - TM-30, Bridge, Open Back w/ 4" H Wire Management Rail, Black Grommet

CPC7024CA668M - TM30-C, U Workstation Credenza, Multi-File - Locking, Right Pedestal, Center Grommet / Black

CPC7029WH330M - LT-LED60", Double Height Wall Hung Overheads
14" D Panel Doors - 4 Door, 60" LED Task Light
FTWH7024 - Full Width Wall Hung Tackboard - 70" Width
Upholstery: Grade 1 - Spinel 3582 - Alabaster 058

CPC1683TW284M - D2, Vertical Half Tower Storage Wardrobe, Panel Door, Hinged Right, Door Lock

Finish: TFL - MTW - Studio Teak Walnut

Edge: Flat

Drawer Pull: PL-115 Matte Black Standard Pull

Key all drawers alike - All Drawers to be locking

Contact: Skip Dunaway

tcginc@bellsouth.net

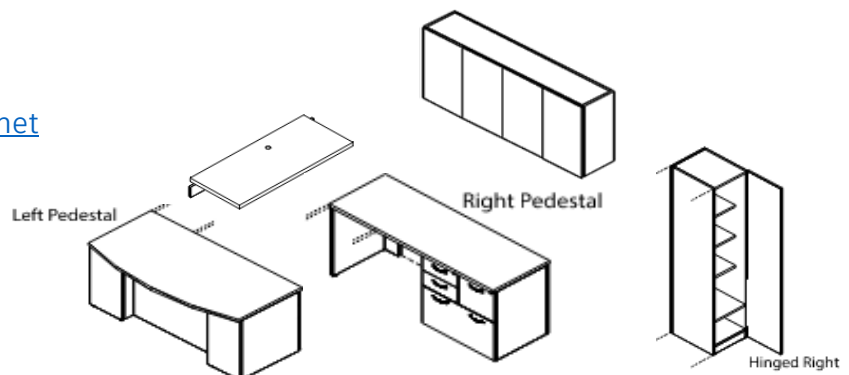



Furniture Specifications

Manufacturer: Darran

Item Number: DA-2

Quantity Req.: 1

Location: Office 145

Product: L Desk - Central Park -TFL

Description: CPC7236DS017M - K31 - TM30-R, Double Breakfront, Bowfront Single Left Pedestal Desk - Locking, Center Drawer, Right Grommet / Black

CPC6024RE223M - TM30, L Workstation Return, Right Pedestal File/File - Locking, Black Grommet

CPC7029WH330M - LT-LED60", Double Height Wall Hung Overheads 14" D Panel Doors - 4 Door, 60" LED Task Light

FTWH7024 - Full Width Wall Hung Tackboard - 70" Width
Upholstery: Grade 1 - Spinel 3582 - Alabaster 058

Finish: TFL - MTW - Studio Teak Walnut

Edge: Flat

Drawer Pull: PL-115 Matte Black Standard Pull

Key all drawers alike - All Drawers to be locking

Contact: Skip Dunaway

tcginc@bellsouth.net

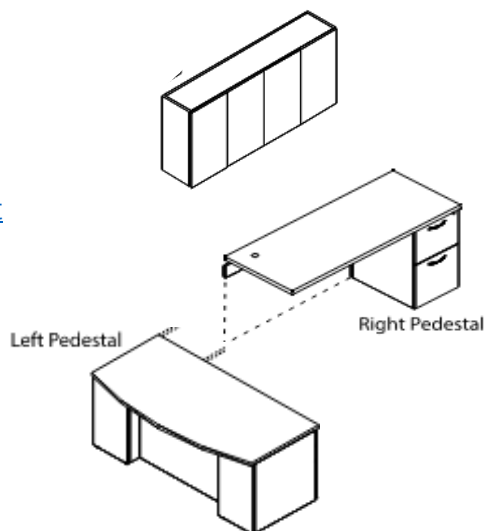



Furniture Specifications

Manufacturer: Darran

Item Number: DA-3

Quantity Req.: 1

Location: Office 146

Product: L Desk - Central Park -TFL

Description: CPC7236DS018M - K31 - TM30-L, Double Breakfront, Bowfront Single Right Pedestal Desk - Locking, Center Drawer, Left Grommet / Black

CPC6024RE222M - TM30, L Workstation Return, Left Pedestal File/File - Locking, Black Grommet

CPC7029WH330M - LT-LED60", Double Height Wall Hung Overheads 14" D Panel Doors - 4 Door, 60" LED Task Light

FTWH7024 - Full Width Wall Hung Tackboard - 70" Width
Upholstery: Grade 1 - Spinel 3582 - Alabaster 058

Finish: TFL - MTW - Studio Teak Walnut

Edge: Flat

Drawer Pull: PL-115 Matte Black Standard Pull

Key all drawers alike - All Drawers to be locking

Contact: Skip Dunaway

tgcinc@bellsouth.net

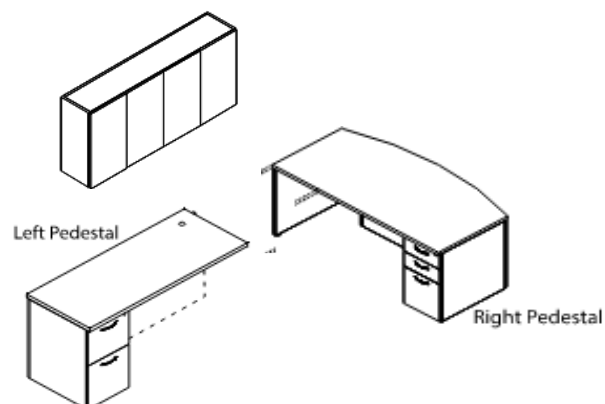



Furniture Specifications

Manufacturer: Darran

Item Number: DA-4

Quantity Req.: 1

Location: Office 149

Product: U Desk - Central Park -TFL

Description: CPC7236DS018M - K31 - TM30-L, Double Breakfront, Bowfront Single Right Pedestal Desk - Locking, Center Drawer, Left Grommet / Black

CPC4824BR151M - TM-30, Bridge, Open Back w/ 4" H Wire Management Rail, Black Grommet

CPC7024CA066M - TM30-C, U Workstation Credenza, Lateral File - Locking, Left Pedestal, Center Grommet / Black

CPC7029WH330M - LT-LED60", Double Height Wall Hung Overheads
14" D Panel Doors - 4 Door, 60" LED Task Light
FTWH7024 - Full Width Wall Hung Tackboard - 70" Width
Upholstery: Grade 1 - Spinel 3582 - Alabaster 058

CPC1683TW283M - D2, Vertical Half Tower Storage Wardrobe, Panel Door, Hinged Left, Door Lock

Finish: TFL - MTW - Studio Teak Walnut

Edge: Flat

Drawer Pull: PL-115 Matte Black Standard Pull

Key all drawers alike - All Drawers to be locking

Contact: Skip Dunaway

tcginc@bellsouth.net



Left Pedestal

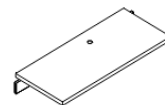
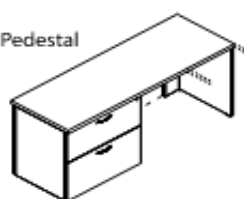

Hinged Left

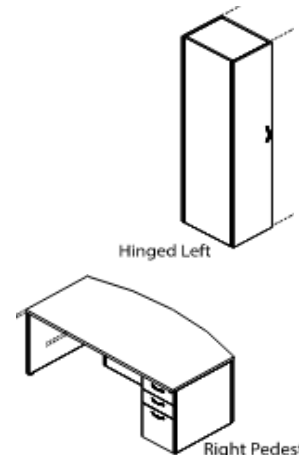

Right Pedestal



Furniture Specifications

Manufacturer: Darran

Item Number: DA-5

Quantity Req.: 1

Location: Office 141

Product: U Desk - Central Park - TFL

Description: CPC7236DS017M - K31 - TM30-R, Double Breakfront, Bowfront Single Left Pedestal Desk - Locking, Center Drawer, Right Grommet / Black

CPC4824BR151M - TM-30, Bridge, Open Back w/ 4" H Wire Management Rail, Black Grommet

CPC7024CA067M - TM30-C, U Workstation Credenza, Lateral File - Locking, Right Pedestal, Center Grommet / Black

CPC7029WH330M - LT-LED60", Double Height Wall Hung Overheads
14" D Panel Doors - 4 Door, 60" LED Task Light
FTWH7024 - Full Width Wall Hung Tackboard - 70" Width
Upholstery: Grade 1 - Spinel 3582 - Alabaster 058

CPC1683TW284M - D2, Vertical Half Tower Storage Wardrobe, Panel Door, Hinged Right, Door Lock

Finish: TFL - MTW - Studio Teak Walnut

Edge: Flat

Drawer Pull: PL-115 Matte Black Standard Pull

Key all drawers alike - All Drawers to be locking

Contact: Skip Dunaway

tcginc@bellsouth.net

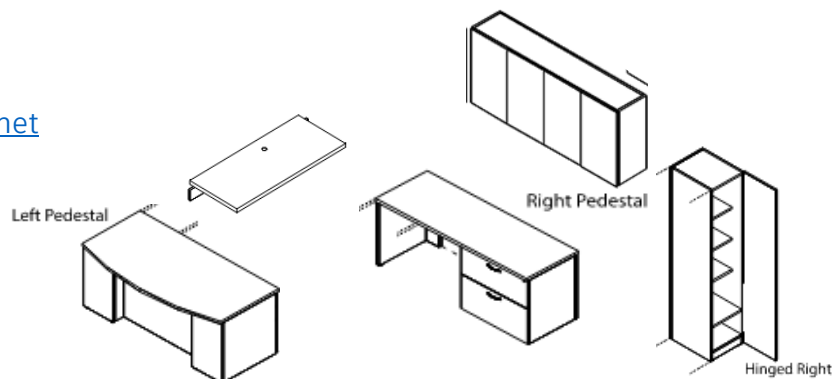



Furniture Specifications

Manufacturer: Darran

Item Number: DA-6

Quantity Req.: 5

Location: Office 144, 145, 146, 149

Product: Vertical Full Tower - Central Park - TFL

Description: CPC3583TW281M - D6 - MOD30

Vertical Full Tower - Storage / File

D6: Delete Doors

MOD30: 83" Delete center partition & add (3) full width shelves

Both Drawers to be locking

Key all drawers alike (per office)

Finish: TFL - MTW - Studio Teak Walnut

Edge: Flat

Drawer Pull: PL-115 Matte Black Standard Pull

Contact: Skip Dunaway

tcginc@bellsouth.net

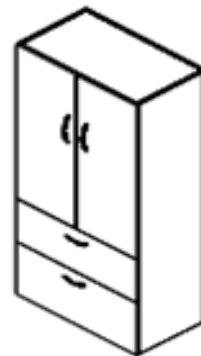



Furniture Specifications

Manufacturer: Darran

Item Number: DA-7

Quantity Req.: 1

Location: Police Chief 142

Product: LED Task Light

Description: LT-LED48

48" Task Light

To be installed on existing central park desk
in Police Chief's Office 142

Contact: Skip Dunaway

tcginc@bellsouth.net



Furniture Specifications

Manufacturer: Indiana

Item Number: IN-1

Quantity Req.: 1

Location: Police Chief 142

Product: Isla Sofa

Model: 3793

Description: Isla Sofa, 2 Arms

Legs: Wood

Leg Finish: Smoky Brown Pear (SBP)

Primary Upholstery COM: Seat & Back

Manufacturer: Momentum

Pattern: Silica Excursion

Colorway: Path

SKU: 09512743

Accent Upholstery COM: Frame & Arms

Manufacturer: Momentum

Pattern: Deka

Colorway: Driftwood

SKU: 09542883

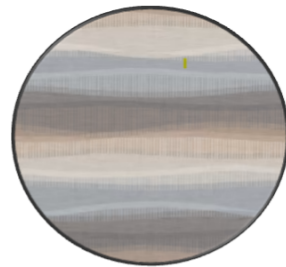

Contact: Lindsay Jeniec

PMC Commercial Interiors

919-228-4019

lindsay@pmccommercialinteriors.com

Tammy Rogers-Markle

Momentum

336-279-4596

trogersmarkle@momtex.com



Furniture Specifications

Manufacturer: Indiana

Item Number: IN-2

Quantity Req.: 3

Location: Offices 144, 145, 146

Product: Isla Settee

Model: 3792

Description: Isla Settee, 2 Arms

Legs: Wood

Leg Finish: Smoky Brown Pear (SBP)

Primary Upholstery COM: Seat & Back

Manufacturer: Momentum

Pattern: Silica Excursion

Colorway: Path

SKU: 09512743

Accent Upholstery COM: Frame & Arms

Manufacturer: Momentum

Pattern: Deka

Colorway: Driftwood

SKU: 09542883

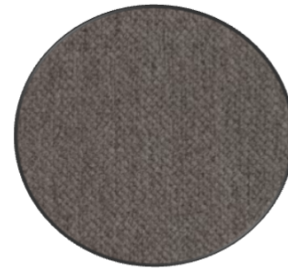
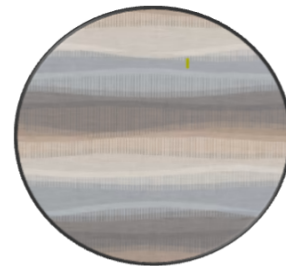

Contact: Lindsay Jeniec

PMC Commercial Interiors

919-228-4019

lindsay@pmccommercialinteriors.com

Tammy Rogers-Markle

Momentum

336-279-4596

trogersmarkle@momtex.com





Furniture Specifications

Manufacturer: Sit on It

Item Number: SOI-1

Quantity Req.: 5

Location: Office 141, 144, 145, 146, 149

Product: Sona Executive Chair

Model: 5723 Y/e3 A111 VG2 C17 B0 B8 KD

Description: Sona Executive Chair
Arm: Black Fixed Loop
Mechanism: Enhanced Synchro w/ Seat Depth Adjustment
Base: Black Nylon
Cylinder: Standard
Casters: Hard Floor & Carpet Casters
No Pull Handle

Back Upholstery: Grade 8
Manufacturer: Momentum
Pattern: Silica Etch
Colorway: Doe

Seat Upholstery: Grade 2
Manufacturer: Sit on It
Pattern: Element
Colorway: Tanzanite

Contact: Mike Luther
Sit on It
336-888-8735
mluther@michaelfluther.com

Tammy Rogers-Markle
Momentum
336-279-4596
trogersmarkle@momtex.com





Furniture Specifications

Manufacturer: Sit on It

Item Number: SOI-2

Quantity Req.: 6

Location: Police Chief 142, Office 141

Product: Freelance - Armless

Model: 5223 US SC8 FG6 C12 B AC

Description: Freelance Armless Guest Chair w/ Casters

Frame: Black

Casters: Hard Floor & Carpet Casters

Back: Plastic - Slate SC8

Seat: Upholstered

Seat Upholstery: Grade 6

Manufacturer: Arc Com

Pattern: Crystal AC-62511

Colorway: Smoke #2



Contact: Mike Luther

Sit on It

336-888-8735

mluther@michaelfluther.com

Lauren Gayle

Arc Com

980-253-9896

lgayle@arc-com.com



Furniture Specifications

Manufacturer: Sit on It

Item Number: SOI-3

Quantity Req.: 1

Location: Lobby 148

Product: Uni Rectangular Laptop Table

Model: 3260 TT9 BF04 TM3 TL16 P3

Description: Uni Rectangular Laptop Table

Base: Charcoal

Top: Laminate

Finish: Frosty White

Contact: Mike Luther

Sit on It

336-888-8735

mluther@michaelfluther.com





Furniture Specifications

Manufacturer: Sit on It

Item Number: SOI-4

Quantity Req.: 6

Location: Lobby 148

Product: Baja Stool

Model: 1171 FT2 S2 FC1 BK3 PS PB ARO CGRF SC7

Description: Baja Bar Stool

Frame: 30" Wire Rod Bar Stool

Frame Finish: Black

Back: Plastic - Low Back

Seat: Plastic

Shell Color: Bisque

Arms: Armless

Glides: Clear Glides w/ Felt



Contact: Mike Luther

Sit on It

336-888-8735

mluther@michaelfluther.com



Furniture Specifications

Manufacturer: Sit on It

Item Number: SOI-5

Quantity Req.: 1

Location: Lobby 148

Product: Parallon Café Table

Model: Top: 3271 TR3636 TL64 GR2 TE5 TBT15

Base: 3272 TR3636 TBT15 BF03 TH42 LS18

Description: Parallon Café Table - Round

Top: 36" Round

Finish: Laminate Grade 2 - Crisp Linen

Edge: Flat Edge

Base: Disc Base

Table Height: 42"

Base Finish: Black

Mobility: Fixed / Glides

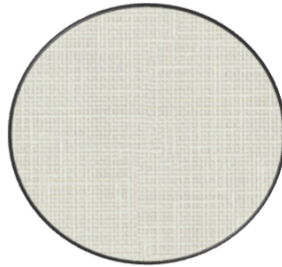

Contact: Mike Luther

Sit on It

336-888-8735

mluther@michaelfluther.com



Furniture Specifications

Manufacturer: Sit on It

Item Number: SOI-6

Quantity Req.: 1

Location: Office 141

Product: Parallon Café Table

Model: Top: 3271 TS3030 TL64 GR2 TE5 TBT15
Base: 3272 TS3030 TBT15 BF03 TH29 LS18

Description: Parallon Café Table - Square
Top: 30" Square
Finish: Laminate Grade 2 - Crisp Linen
Edge: Flat Edge

Base: Disc Base
Table Height: 29"
Base Finish: Black
Mobility: Fixed / Glides

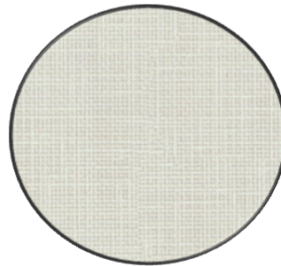

Contact: Mike Luther
Sit on It
336-888-8735
mluther@michaelfluther.com



Furniture Specifications

Manufacturer: Sit on It

Item Number: SOI-7

Quantity Req.: 1

Location: Police Chief 142

Product: Parallon Table Base & Quartz Top

Model: Top: Quartz

Base: 3272 TR3636 TBT15 BF03 TH29 LS18

Description: Top: 36" Round

Manufacturer: Cosentino - Silestone

Color: Bianco Calacatta

Edge: Eased

Parallon Café Table Base

Base: Disc Base

Table Height: 29"

Base Finish: Black

Mobility: Fixed / Glides

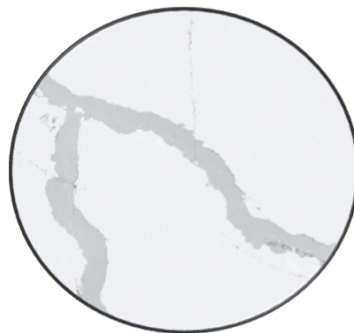

Contact: Mike Luther

Sit on It

336-888-8735

mluther@michaelfluther.com

Melanie Winstead

Cosentino

984-389-6661

mwinstead@cosentino.com

